

Operating, Servicing, and Safety Manual

Model # 950

180° Manual Tube Bender



CAUTION: Read and Understand

These Operating, Servicing, and
Safety Instructions, Before Using
This Machine.

1-800-467-2464

10 Cooperative Way Wright City, MO 63390

P.O. Box 110 Foristell, MO 63348

www.mittlerbros.com

SAFETY

The purpose of the safety section of this manual is to inform operators and maintenance personnel of the precautions to be taken while operating or servicing the machine. The following are a few basic guidelines to follow, but as with any type of machinery good judgment and a safe attitude should be applied at all times.

1. Always wear safety clothing, including eye protection and protective footwear, while operating or servicing the machine.
2. Keep all body parts and any foreign objects away from the nose bar and clamping area of the brake while in operation.
3. Never use a pipe or bar on the clamp handles for additional leverage.
4. Do not operate the machine if it has been damaged or is not operating properly.
5. Do not wear jewelry (watches, rings, necklaces, etc.), or loose fitting clothing while operating or servicing the machine.
6. The machine should only be operated or serviced by properly trained, authorized personnel.
7. Replacement parts should have the same specification and operation as the original parts on the machine.
8. All guards and covers must be in place before operating the machine.
9. Before starting the machine, be sure it is set up properly.
10. Do not operate or service any machine while under the influence of drugs or alcohol.

NOTE: THESE SAFETY RULES ARE FOR YOUR BENEFIT TO HELP PREVENT INJURY TO YOURSELF AND/OR YOUR CO-WORKERS. REVIEW ALL SETUP AND OPERATING PROCEDURES, WHETHER COVERED OR NOT, IN THIS MANUAL TO HELP INSURE SAFE OPERATION OF THE MACHINE.

Machine Setup

1. Remove machine from packaging.
2. Place machine on table.
3. Remove center pivot point ½” shoulder bolt and washer.
4. Install Main shoe, Degree Wheel, and Insert center pivot point ½” shoulder bolt and washer through main shoe and Degree Wheel and thread into frame assembly.
5. Remove Clamp Roll ½” shoulder bolt and washer.
6. Install Eccentric Clamp Roll and Insert ½” shoulder bolt and washer through Eccentric Clamp Roll and Thread into Frame Assembly.
7. Remove Follow Roll pin.
8. Install Follow Roller and Insert Follow Roll pin through roller and Frame Assembly.
9. Install thumb Screw on Degree Wheel and Reference Pointer on Follow Arm.
10. Clamp Tube Bender in your Vise or securely fasten to a bench or table.
11. Rotate Follow Arm back so it is parallel with main frame.
12. Insert tubing between Main Roll and Eccentric Clamp Roll.
13. Rotate Eccentric Clamp Roll towards Main Roll to securely hold tubing.
NOTE: Pull back on tubing to ensure clamp roll has a secure grip on tube.
14. Pull Follow Arm and Roll until it contacts tubing.
15. Loosen thumb screw and rotate Degree Wheel so “0” aligns with pointer.
16. Place 3 to 5 foot long heavy wall tubing over Follow Arm shaft for additional leverage.
17. Bend tubing by pulling Follow Arm/ Roll until arrow aligns with Degree Wheel desired bend point.

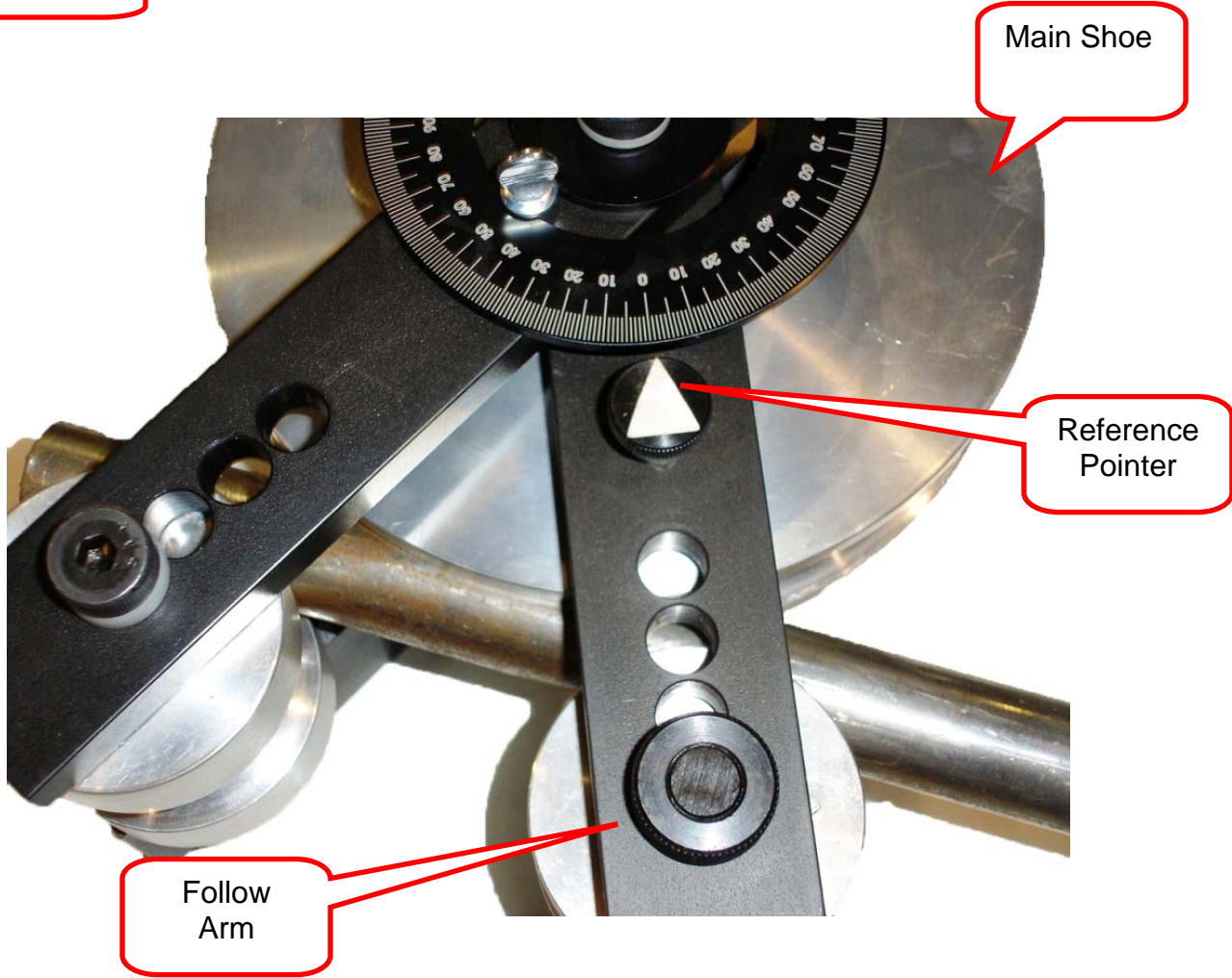
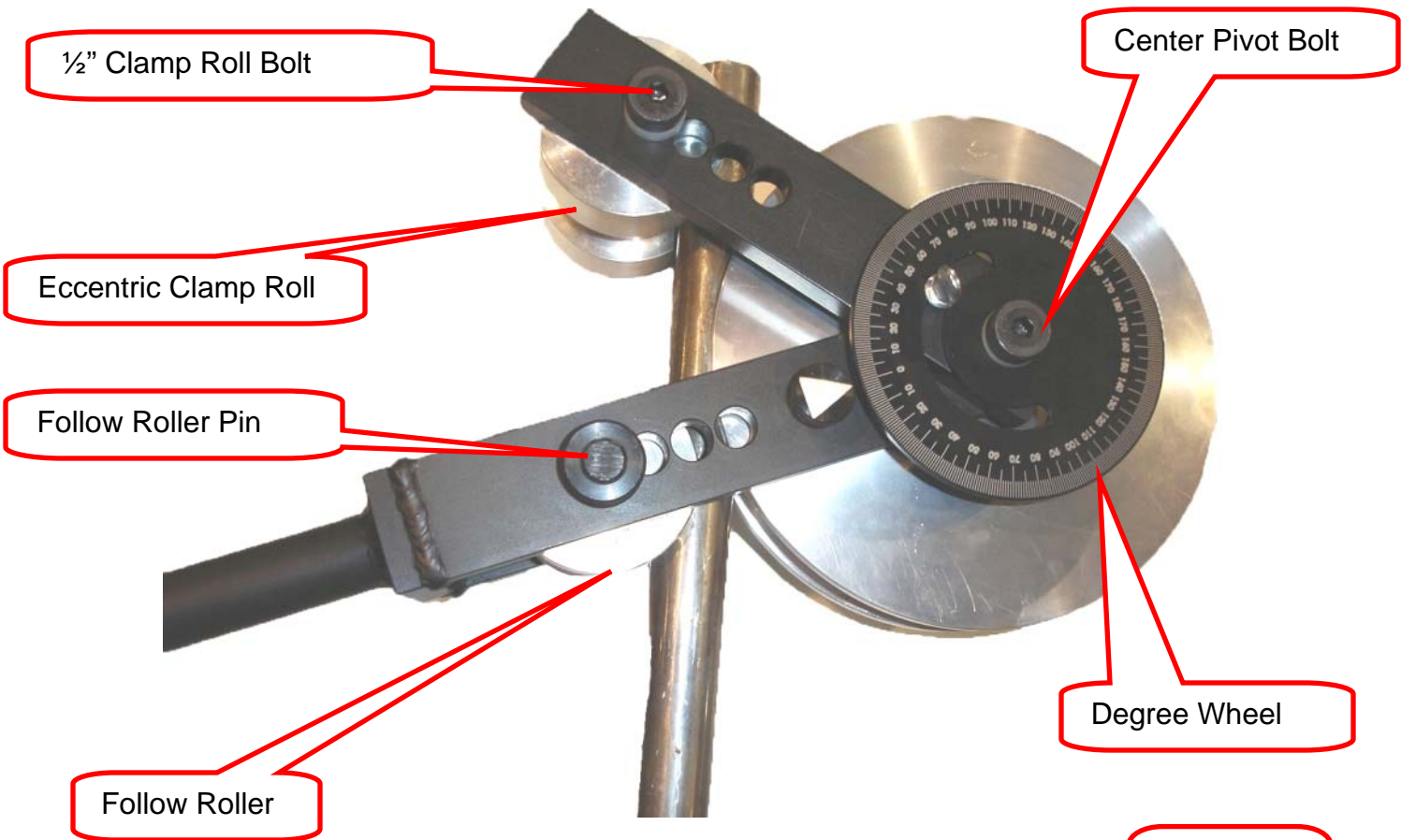

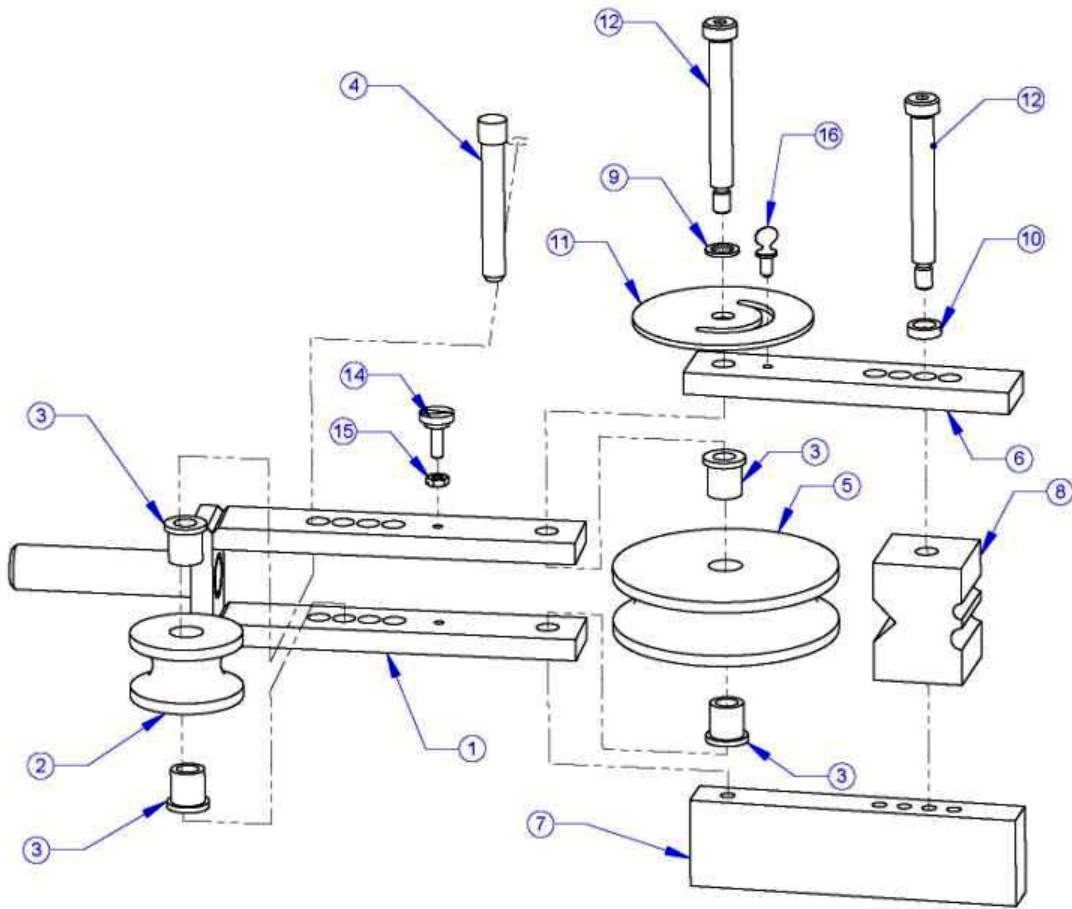

ITEM NO.	PART NUMBER	Description	Default/ QTY.
1	950-A01	Handle Assembly	1
2	950-008	Follower	1
3		Bushing	4
4	950-009	Pull Pin	1
5	950-007	Shoe	1
6	950-003	Top Plate	1
7	950-004	Bottom Plate	1
8	950-006	Stop Block	1
9	950-101	Thin Delrin washer	1
10	950-102	Thick Delrin Washer	1
11	950-103	Degree Wheel	1
12	SHSCREW 0.5x3.5-N	1/2" shoulder screw x 3-1/2"	2
13	HX-SHCS 0.25-20x0.75x0.75-N	1/4-20 x 3/4" SHCS	1
14	950-104	Screw Cap	1
15	HJNUT 0.2500-20-D-N	1/4-20 Jam Nut	1
16	0.25x0.51, Thumb Screw, Type A, Flat Point-N	1/4-20 x 1/2" Thumb Screw	1

Optional Equipment

Round Shoe Set

950-S05	1/2" OD - 2" Radius Round Shoe Set w/ Eccentric. Roll
950-S04	5/8" OD - 2-1/2" Radius Round Shoe Set w/ Eccentric. Roll
950-S03	3/4" OD - 2-1/2" Radius Round Shoe Set w/ Eccentric. Roll
950-S02	7/8" OD - 3-1/2" Radius Round Shoe Set w/ Eccentric. Roll
950-S01	1" OD - 3-1/2" Radius Round Shoe Set w/ Eccentric Roll
950-S20	3/8" / 1/2" OD- 2" Radius Combo Round Shoe Set w/ Eccentric Roll.







Square Shoe Set

Note: Square Shoe Sets NOT Included in Free Sets with Bender Purchase

950-S10	1/2" Square - 2" Radius Shoe Set w/ Eccentric. Roll
950-S09	5/8" Square - 2-1/2" Radius Shoe Set w/Eccentric. Roll
950-S08	3/4" Square - 2-1/2" Radius Shoe Set w/ Eccentric. Roll
950-S07	7/8" Square - 3-1/2" Radius Shoe Set w/ Eccentric. Roll
950-S06	1" Square - 3-1/2" Radius Shoe Set w/ Eccentric. Roll
950-S21	3/8" / 1/2" Square - 2" Radius Combo Shoe Set w/ Eccentric.

Bend Protractors



	2100-4	4" Protractor Assembly
	2100-5	5" Protractor Assembly
	2100-6	6" Protractor Assembly
	2100-7	7" Protractor Assembly
	2100-8	8" Protractor Assembly
	2100	4" Thru 8" Protractor Set

CAUTION: Read and Understand

These Operating, Servicing, and
Safety Instructions, Before Using
This Machine.

1-800-467-2464

10 Cooperative Way Wright City, MO 63390

P.O. Box 110 Foristell, MO 63348

1-636-745-7757 Fax 1-636-745-2874

www.mittlerbros.com